



TrueFlame Gas Grill User Manual
Models: TFE25-NG; TFE32-NG
TFE25-LP; TFE32-LP

ATTENTION:

INSTALLER: PLEASE LEAVE THESE INSTRUCTIONS WITH THE CONSUMER.
CONSUMER: PLEASE READ & RETAIN THESE INSTRUCTIONS FOR FUTURE REFERENCE AND BEFORE INSTALLING OR OPERATING.

 **DANGER**

If you smell gas:

- Shut OFF gas supply to the appliance.
- Extinguish any open flame.
- Open lid.
- If odor continues, keep away from the appliance and immediately call your gas supplier or your fire department.

 **WARNING**

- Do not store or use gasoline or other flammable liquids or vapors in the vicinity of this or any other appliance.
- An LP cylinder not connected for use shall not be stored in the vicinity of this or any other appliance.

This appliance is designed as an “**ATTENDED APPLIANCE**”.
DO NOT leave this appliance burning when unattended.

WARNINGS

READ THIS MANUAL CAREFULLY AND COMPLETELY BEFORE USING YOUR GRILL TO REDUCE THE RISK OF:

Fire, burn hazard, personal injury or property damage, improper installation or servicing electric shock.

THIS PRODUCT IS DESIGNED FOR OUTDOOR USE ONLY

Improper installation, adjustment, alteration, service or maintenance can cause property damage, injury or death. Read this manual thoroughly before installation, use, or servicing of this product.

CODE AND SUPPLY REQUIREMENTS:

This grill must be installed in accordance with local codes and ordinances, or, in the absence of local codes, with the latest National Fuel Gas Code (ANSI Z223.1/NFPA 54), or Natural Gas and Propane Storage and Handling Installation Code (CSA-B149.1)

IF YOU SMELL GAS:

Shut off all gas supply lines to the grill. Extinguish any open flames. Carefully open the lid. Remember, it may be extremely hot! If odor continues, keep everyone away from the grill and immediately call your gas supplier or your fire department.

This appliance is designed as an “**ATTENDED APPLIANCE**”. **DO NOT** leave this appliance burning when unattended.

EXPLOSION HAZARD:

DO NOT use the grill as a storage area for flammable materials. Keep area clear and free from combustible materials, gasoline, and other flammable vapors and liquids. Failure to do so can result in death, explosion, or fire. An LP cylinder not connected for use shall not be stored in the vicinity of this or any other appliance.

The outdoor cooking gas appliance and its dedicated shutoff valve must be disconnected from the gas supply piping system during pressure testing of that system at test pressures in excess of .5 psi (3.5kPa).

The outdoor cooking gas appliance must be isolated from the gas supply piping system by closing its dedicated manual shutoff valve during any pressure testing of the gas supply piping system at test pressures equal to or less than .5 psi (3.5kPa).

WARNING

NEVER cover slots, holes, or passage in the oven bottom or cover an entire rack with material such as aluminum foil. Doing so blocks air flow through the oven and may cause carbon monoxide poisoning.

Aluminum foil linings may trap heat causing a fire hazard.

CALIFORNIA PROPOSITION 65

WARNING

This product is designed to operate with one of the following fuel sources: Liquid Propane or Natural Gas. The fuel used to operate this product, and the products of combustion of such fuel, can expose you to chemicals including Benzene which is known to the State of California to cause cancer, birth defects and other reproductive harm and Carbon Monoxide which is known to the State of California to cause birth defects or other reproductive harm. (For more information go to: www.p65Warnings.ca.gov.)

TABLE OF CONTENTS

Warnings	2 & 4
Before Grilling	5
Installation	6-7
Gas Requirements	8-10
Custom-Built Enclosures/Island	11
Operation & Maintenance Tips	12-14
Grill Illustrations	15
Illustrated Parts	16
Parts List & Replacement Parts	17
Warranty	18
Notes	19

**PART #: TFE25-NG; TFE32-NG
TFE25-LP; TFE32-LP**

(Natural Gas & Liquid Propane Gas Configurations)

For warranty information and to register your grill visit,
amddirect.com/register



To view on your phone, scan the QR code on your smart phone's camera app. (For Android devices, use Google Lens.)

THANK YOU

Thank you for your purchase. We'd like to welcome you to the TrueFlame family of luxury outdoor kitchen products, and we look forward to being a part your home for years to come. As a family business with over 30 years of industry experience, we aim to deliver exceptional quality and personal service.

Welcome to the TrueFlame family and we hope you love your new grill!

FOR YOUR RECORDS

Please record the following information and refer to it when contacting TrueFlame or an authorized dealer. The serial number is located on the rating plate. The rating plate is located on the underneath side of the drip tray.

INSTALLER

Please leave this manual for the owner

Serial Number: _____

Serial Number located underneath Drip Tray

Model: _____

Date of Purchase: _____

Place of Purchase: _____

WARNINGS

SAFETY AND INSTALLATION WARNINGS

- Please read all instructions before installation or operating your gas grill to prevent injury and appliance damage
- All gas grills will get hot during use. Use extreme caution when operating the grill
- Do not touch hot surfaces. Always use the handle to open or close the grill
- Never use dented, rusty or damaged propane cylinders. Never store additional or empty propane cylinders in the grill cabinet or in the vicinity of this or any other appliance
- Close supervision is necessary when this or any appliance is used near children. Keep children away from the grill during operation and until the grill has cooled off
- Children should never be left alone or unattended in an area where a grill is located. Place your grill well away from areas where children play. Do not store items that may interest children in or around the grill, in the cart, or in the masonry enclosure
- Never move the grill when hot. When in use, portions of the grill are hot enough to cause severe burns.
- Always maintain the required clearances from combustibles as detailed. The grill is designed for outdoor use only. Never use in a garage, building, shed, breezeway, or other enclosed area. Do not use this grill under any unprotected overhead combustible construction
- Gas grills are not designed or certified for and are not to be installed in or on recreational vehicles, portable trailers, boats or any other moving installation
- Always have an ABC Fire Extinguisher accessible — never attempt to extinguish a grease fire with water or other liquids
- Storing your grill: Store your grill in a well-ventilated area. If stored indoors, detach and leave L.P. cylinder outdoors in a well-ventilated area away from heat and away from where children may tamper with it
- Keep any electrical supply cord and the fuel supply hose away from any heated surfaces. Electrical cords should be placed away from walkways to avoid tripping hazard
- Do not repair or replace any part of the grill unless specifically recommended in this manual. Other service should be performed by a qualified technician
- If the grill is installed by a professional installer or technician, be sure that he/she shows you where your gas supply shut-off is located. All gas lines must have a shut-off that is readily and easily accessible. If you smell gas, check for gas leaks immediately. Check only with a soap and water solution. Never check for gas leaks with an open flame
- Do not twist the gas supply hose
- Inspect the L.P. gas supply hose prior to each use of the grill. If there is evidence of excessive abrasion or wear, or the hose is cut, it must be replaced before using the grill
- The use of accessories, regulators, or components not recommended by the appliance manufacturer may cause injuries and will void warranty
- Never light the grill with the hood closed and be certain the burners are positioned and seated over the gas valves and on the burner support
- Never lean over the cooking surface when lighting or operating the grill
- Use barbecue tools with wood handles and insulated oven mitts when operating the grill
- Be sure the gas supplied to the grill conforms to the model you purchased. A natural gas grill requires natural gas to operate; a liquid propane grill requires liquid propane to operate
- Never connect the appliance to an unregulated gas supply line. Grills operated without a regulator are unsafe and will not be serviced until installed properly and safely. Unsafe operation without a gas regulator will void the warranty
- Grills operating with natural gas must be installed with the NG regulator supplied with the unit and set to 4.0" of water column pressure
- Grills operating with Liquid Propane must be installed with an LP regulator and set to 11" of water column pressure

BEFORE GRILLING

UNPACKING YOUR GRILL

Included with your TrueFlame grill are the following loose items:

Burner Covers: TFE25(3), TFE32(4)
Cooking Grates: TFE25(3), TFE32(4)
Drip Tray: TFE25(1), TFE32(1)
Heat Zone Separators: TFE25(2), TFE32(3)
Manual: TFE25(1), TFE32(1)
Warming Rack: TFE25(1), TFE32(1)

Set of orifices

- If grill is factory set LP, NG orifices will be included
- If grill is factory set NG, LP orifices will be included
- The drip tray will be at the bottom of the unit and will slide into the drip tray support brackets.
- Above the heat shields are the Burners (already installed).

CHECK FOR SHIPPING DAMAGED:

VISIBLE DAMAGE

If your shipment arrives with visible damage to the box/carton, be sure the damage is noted on the bill of freight or express receipt and signed by the person making the delivery. File claim for damages immediately, regardless of the extent of damage.

CONCEALED DAMAGES

If damages are unnoticed until the grill is unpacked, notify the transportation company or carrier immediately and file a concealed damage claim with them. This should be done within (5) days of the delivery date. Be sure to hold on to the box/carton for inspection. We cannot assume responsibility for damage or loss incurred in transit.

IMPORTANT NOTES:

BE MINDFUL OF WIND DIRECTION

Using your grill in windy conditions may disrupt the front-to-back air flow that the grill is designed for. If you notice that the temperature gauge fails to rise while grilling with all burners on high and the hood closed, then be careful. If wind keeps the heat from exiting the rear of the grill, then the control panel and knobs could become extremely hot. Your grill pulls air in through its front and vents hot gases out the rear hood; do not grill if wind is entering the rear hood of the grill.

GAS LINE LENGTH

Keep all gas supply lines as short as possible. Gas lines lose pressure over distance and with each elbow or "T" fitting added. This drop in pressure affects grill performance.

PROPER LEVELING

PROPER LEVELING DURING INSTALLATION IS CRITICAL. A GRILL THAT IS OUT OF LEVEL WILL CAUSE ERRATIC BURNER COMBUSTION AND INEFFICIENT, UNEVEN HEATING. THE GRILL SHOULD BE LEVEL IN ALL DIRECTIONS. ADJUSTMENTS MAY NEED TO BE MADE EACH TIME WHEN MOVING A FREESTANDING UNIT.

CONSTRUCTION ZONES

Keep all stainless steel products away from construction zones. Construction debris such as (but not limited to) stone dust, stucco, and lime dust could damage or permanently discolor stainless steel products. Keep all caustic chemicals including chlorine and pool cleaning products away from stainless steel at all times.

INSTALLATION

TrueFlame Grills are a “built-in” gas grill that requires a non-combustible island/enclosure. Use Figure 1 and Table 1 as a guide.

It is recommended to use cement board with steel studs and proper ventilation per local codes. A minimum 4-inch vent size is required, one at the top and one at the bottom to provide free flowing air keep the island cool during operation of the grill.

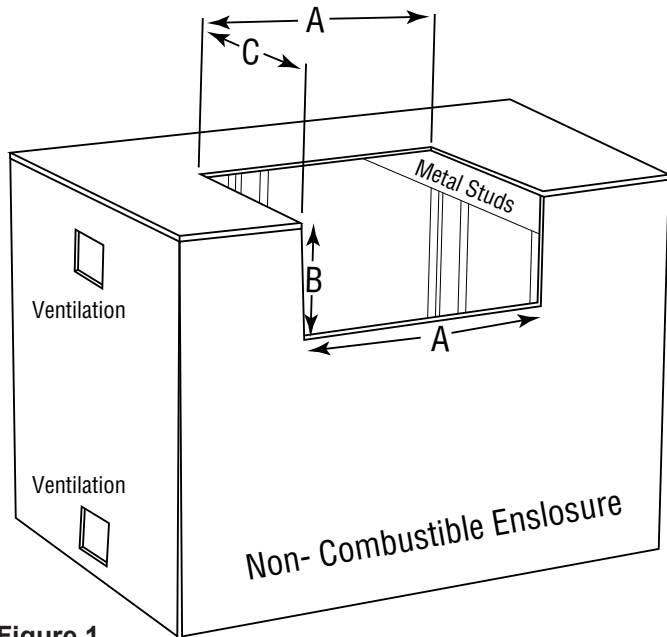

Figure 1

⚠ ALL BBQ ISLANDS MUST BE MANUFACTURED FROM “NON COMBUSTIBLE” MATERIALS.

ISLAND CUT OUT DIMENSIONS

GRILL MODEL	A: WIDTH	B: HEIGHT	C: DEPTH
TFE25	23 1/4"	8 1/4"	19 1/2"
TFE32	30 3/4"	8 1/4"	21 1/4"

Table 1

OVERALL PRODUCT DIMENSIONS

GRILL MODEL	A: WIDTH	B: HEIGHT	C: DEPTH
TFE25	25"	22 1/2"	25 1/2"
TFE32	32 1/2"	21 3/4"	25 1/2"

Table 2

Note: Refer to page 10 for Custom Built-In Enclosures/ Islands when building.

MINIMUM GRILL CLEARANCES:

Minimum clearances between the grill and any side wall or rear wall must fall within one (or more) of the following:

IMPORTANT NOTE:

Clearance from the grill and a non-combustible wall

(i.e. brick wall, see Figure. 2). The grill requires a minimum of 4” clearance from the right side, left side and rear (back) of the grill from any non-combustible wall. This allows for proper ventilation and helps prevent dangerous overheating.

If a non-combustible backsplash exists, it must have a minimum of a 4” clearance from the rear of the grill (to allow for proper ventilation and help prevent dangerous overheating. Clearance Figure 2).

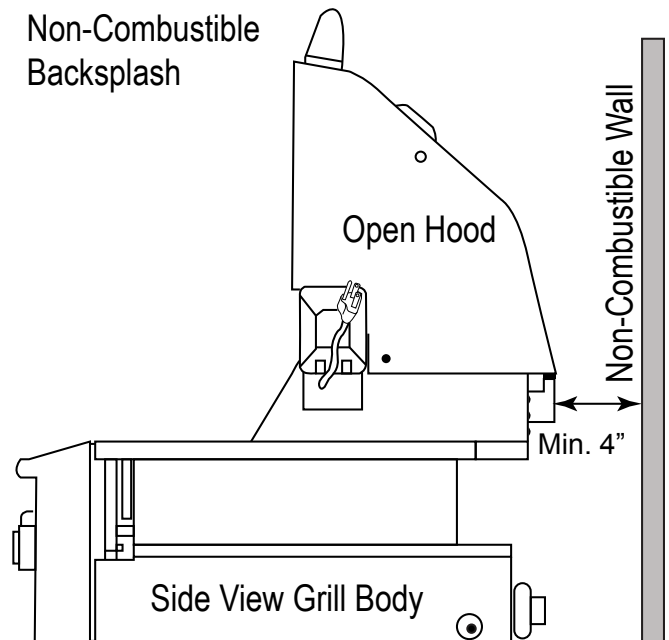

Figure 2

IMPORTANT NOTE:

This 4” backsplash clearance must first be met prior to any non-combustible walls beginning behind it.

The grill must have a minimum of 14” clearance from the right side, left side and rear (back) of the grill from a protected combustible wall. Refer to Figure 3.

INSTALLATION

Clearance from the grill and protected combustible wall

(i.e. A non-combustible wall in front of a combustible wall to serve as a barrier. This can be accomplished by brick or a metal stud finished with non-combustible substrate. See Figure 3). The grill must have a minimum of 14" right, left and rear clearance from the protected combustible wall. (4" non-combustible material clearance, plus an additional 10" clearance between the grill and protected wall.)

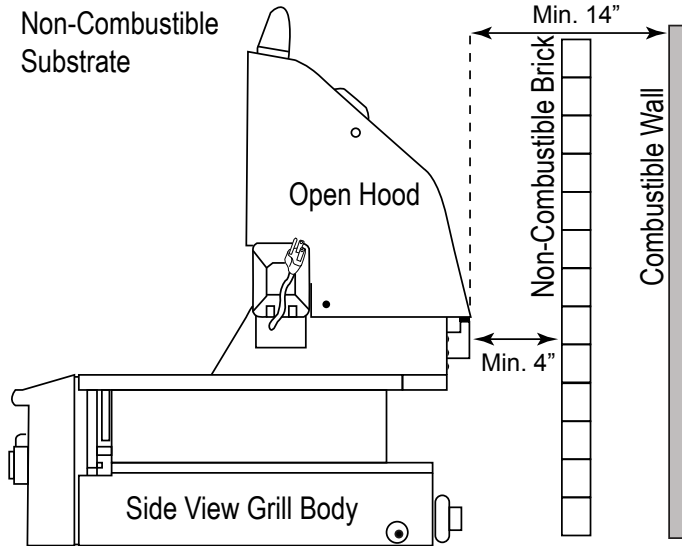

Figure 3

Clearance from the grill and combustible wall

(Clearance Figure 4). The grill must have a minimum clearance of 18" from the right side, left side and rear of the grill to any combustible wall.

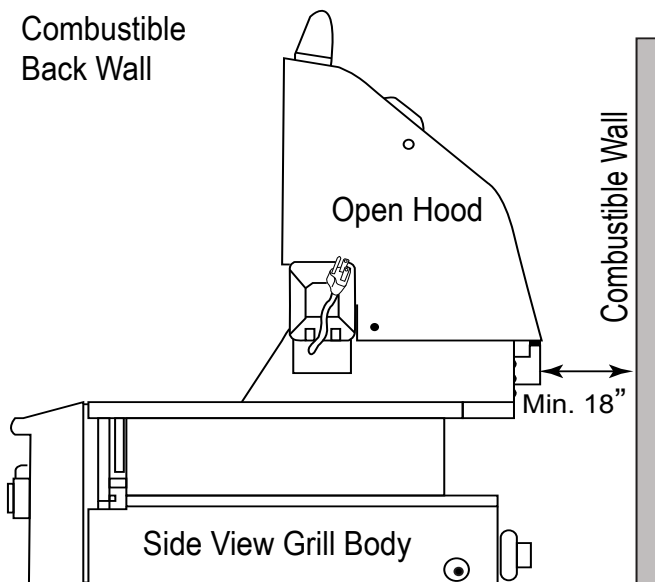

Figure 4

OVERHEAD CONSTRUCTION AND EXHAUST HOOD REQUIREMENTS

This grill is designed for outdoor use only.

DO NOT use this grill inside a building, garage, or enclosed area.

DO NOT use this grill in or on a recreational vehicle or boat.

When installing this grill in a combustible surround, an TrueFlame insulating jacket/grill liner must be used.

A minimum five (5) foot clearance is required between the countertop and the overhead construction.

When the grill is installed under a combustible overhead construction, the area above the cooking surface of the grill must be used with an exhaust hood. The exhaust hood provides the protection for the combustible overhead construction. See Figure 5.

IMPORTANT NOTE:

- DO NOT use this appliance under unprotected combustible overhead construction.
- When installed under overhead non-combustible construction, an exhaust hood is highly recommended.

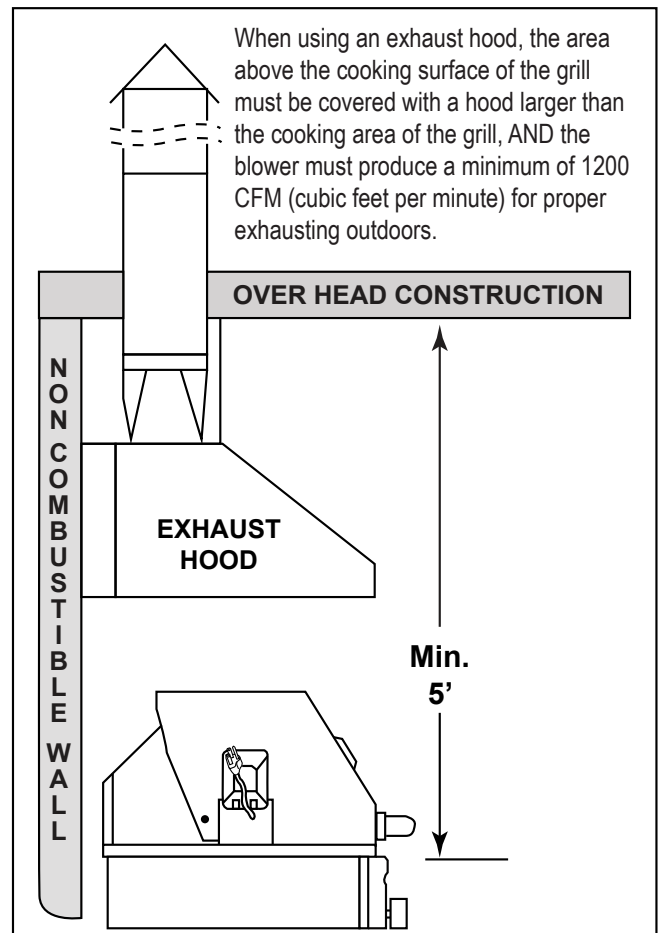

GAS REQUIREMENTS

WARNING

GAS LINES

Never connect a gas line directly to the grill. A pressure regulator must be installed on all gas equipment. Removing or failing to install the pressure regulator can result in fire and serious personal injury and will void the warranty

GAS PRESSURE REQUIREMENTS

Ensure the gas supplied meets the minimum pressure requirements. See Table 3 for gas requirements measure in Water Column (W.C.) pressure.

Pressure	Natural Gas	Propane Gas
Min. Inlet	4.0" WC (1.00.kPa)	10.0" WC (2.49 kPa)
Max. Inlet	7.0" WC (1.74 kPa)	14.0" WC (3.48 kPa)

Table 3

NOTE: Both the regulator and burner orifices have been tuned for the type of gas specified on the rating plate. Converting to a different type of gas requires a conversion kit. Conversion kits are included with this grill and located with the manual. Converting gases may require additional parts not included with this grill. (See Gas Conversion section for details).

IMPORTANT:

All electrical outlets in the vicinity of the grill must be properly grounded in accordance with local codes, or in the absence of local codes, with the National Electrical Code, ANSI/NFPA 70 or the Canadian Electrical Code, CSA C22.1, whichever is applicable.

Keep all electrical supply cords and fuel supply hoses away from any heated surface.

NATURAL GAS REQUIREMENTS

- TrueFlame recommends that only qualified professionals perform the required plumbing on this product.
- Check the Rating Plate to make sure the gas supply you are hooking up to is the gas type the grill is manufactured for.
- To ensure satisfactory performance, the gas supply line must be sized to accommodate the total BTU requirements of all the gas-fired equipment that will be connected to that line.
- In no case should pipe less than 1/2" inside diameter or 1" outside diameter ever be used to connect this product.

CONNECTING TO THE NG REGULATOR

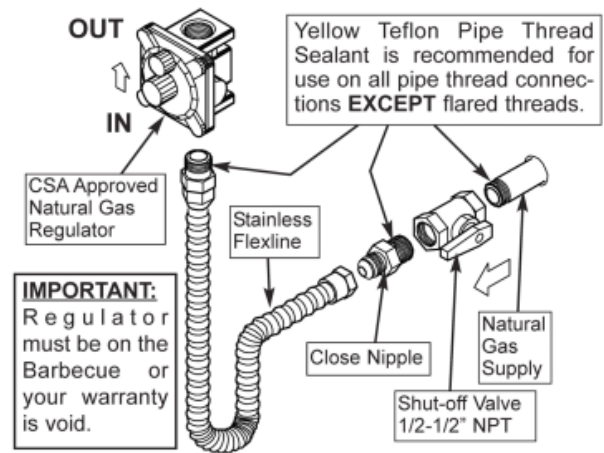

Figure 6

NOTE: DO NOT use any tape, pipe dope or threading compound on any flare fitting. This will cause a clog in the regulator and prevent your grill from functioning properly.

GAS REQUIREMENTS

SAFE USE AND MAINTENANCE OF PROPANE GAS CYLINDERS

IMPORTANT FOR YOUR SAFETY
READ AND FOLLOW ALL WARNINGS PROVIDED WITH THE PROPANE GAS CYLINDER.
When operating a Propane gas cylinder, these instructions and warnings **MUST** be observed.
FAILURE TO DO SO MAY RESULT IN A SERIOUS FIRE OR EXPLOSION

CYLINDER/CONNECTOR REQUIREMENTS

- a. Propane gas cylinders, valves and hoses must be maintained in good condition and inspected before each use of an appliance. They must be replaced if there is any visible damage. If the hose is cut or shows any excessive abrasion or wear, it must be replaced before using the appliance. (See section e.)
- b. This unit, when used with a cylinder, should be connected to a standard 5-gallon (20 lb.) propane gas cylinder equipped with a listed overfilling prevention device.
- c. Cylinder dimensions should be approximately 12" (30.5cm) in diameter and 18" (45.7cm) high. Cylinders must be constructed and marked in accordance with the U.S. Department of Transportation (D.O.T.) Specifications for LP-Gas Cylinders, or the standard for Cylinders, Spheres, and Tubes for Transportation of Dangerous Goods and Commission, CAN/CSA-B339, as applicable.
- d. The cylinder used must include a collar to protect the cylinder valve, and the cylinder supply system must be arranged for vapor withdrawal.
- e. The pressure regulator and hose assembly used must match the specification for Type I by ANSI Z 21.58/CGA 1.6 (See Figure 7)
- f. The propane gas cylinder valve must be equipped with a cylinder connection device, described as Type I in the standard defined in paragraph "e" above. This device is commonly describes as an Acme thread coupler.
- g. If the propane gas cylinder comes with a dust cap, place the dust cap on the cylinder valve outlet whenever the cylinder is not in use.

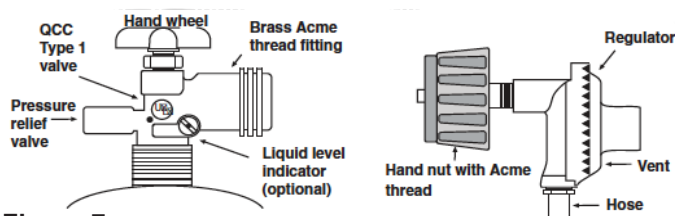

Figure 7

121223

COUPLER OPERATION

To connect the regulator/hose to the Propane gas cylinder valve fitting:

Press the hand nut on the regulator over the Acme thread fitting on the cylinder valve. Turn the hand nut clockwise to engage the threads and tighten until snug. The pliers of a wrench should not be necessary. Only cylinder marked "Propane" may be used.

To Disconnect:

Turn the hand nut counterclockwise until detached. See Figure 7.

IMPORTANT: Before using the unit, and after each time the cylinder is removed and reattached check the hose for wear (See section "a") and check all connections for leaks. Turn OFF the unit valves and open the main cylinder valve, then check connections with soapy water. Repair any leaks before lighting the unit.

CAUTION: Always turn the Propane cylinder main valve OFF after each use, and before moving the unit and cylinder or disconnecting the coupling. This valve must remain closed and the cylinder disconnected while the appliance is not in use, even though the gas flow is stopped by a safety feature when the coupler is disconnected.

Carefully inspect the hose assembly each time before the gas is turned ON. A cracked or frayed hose must be replaced immediately.

If the appliance is stored indoors, the cylinder must be disconnected and removed. Disconnected cylinders must be stored outdoors, out of reach of children, with threaded valve plugs tightly installed, and must not be stored in a building, garage, or any other enclosed area.

FOR YOUR SAFETY

- DO NOT store a spare Propane gas cylinder under or near this appliance.
- NEVER fill the cylinder beyond 80% full.
- IF THE INFORMATION IN SECTIONS "a" AND "b" IS NOT FOLLOWED EXACTLY, A FIRE CAUSING DEATH OR SERIOUS INJURY MY OCCUR.

For proper ventilation and enclosure requirements, see the Enclosure Installation and Ventilation Requirements on pages 6 and 10.

GAS REQUIREMENTS

CONNECTING TO A SIDE BURNER

You will need a 'T' adapter fitting (not provided) or similar connection to connect a single gas line to both a side burner and a grill. We recommend a licensed gas technician install all gas lines. See below Figure 8 for installation of a 'T' adapter.

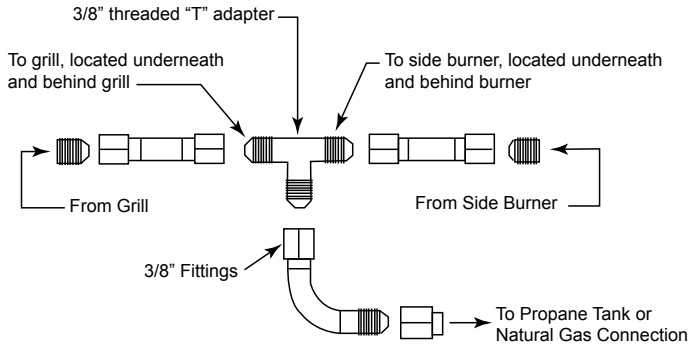

IMPORTANT:

Ventilation is required in the enclosure on opposite sides to create cross-ventilation. Liquid propane is heavier than natural gas and vents should be located near the bottom of the enclosure.

TESTING FOR LEAKS

Create a soapy water solution of 1 part soap and 3 parts water. Confirm that all control knobs are in the off position. Turn on the fuel supply.

For Natural Gas, turn the valve handle $\frac{1}{4}$ turn to align with the gas flow. For LP, turn the cylinder valve counter clockwise one full rotation. Apply the soap solution generously by paint brush or squirt bottle on all connections and fittings. If bubbles appear to grow on any of the connections, you have a gas leak. IMMEDIATELY turn OFF the gas supply. Wash off the soapy solution with cold water and dry. Tighten the loose joint or replace the faulty part with manufacturer-recommended replacement parts.

DO NOT attempt to repair the L.P. cylinder valve if it is damaged. The only way to safely resolve a damaged cylinder is to replace it by calling an authorized gas appliance service technician or an LP gas dealer. Repeat the leak test to ensure that no leaks are present. Do not use the appliance until the leak is corrected.

LIQUID PROPANE INSTALLATION

LP gas grill models are designed for use with a standard 20 lb. liquid propane gas (LP) tank with type (1) valve connections. (Not included)

A dented or rusty LP tank may be hazardous and should be avoided. If in doubt, have it checked by your LP supplier. Always check for leaks after every LP tank change. (See Checking For Leaks)

LP Tanks must be stored outdoors in a well-ventilated area out of the reach of children. If your grill is stored indoors, the LP tank must be stored outside, in upright position and away from excessive heat.

IMPORTANT:

All installation and all installation parts must conform to local codes with the National Electrical Code, ANSI Z223.1/ NFPA 70 latest edition and the National Fuel Gas Code ANSI Z223.1/NFPA 54 in the U.S. and CGA-B149.1/.2 in Canada

PROPANE GAS TANK REQUIREMENTS

FILLING AND REFILLING LP GAS CYLINDERS

All purging and refilling of LP gas cylinders must be performed by qualified personnel in the LP gas industry. Never store a spare LP gas cylinder under or near this appliance.

Never fill the LP gas cylinder beyond 80 percent full. Failure to follow these instructions may result in explosion, personal injury or death.

CUSTOM-BUILT ENCLOSURES/ ISLANDS

VENTILATION REQUIREMENTS FOR ALL ENCLOSURES

FOR ALL GAS TYPES:

Natural Gas, Household Propane or LP Cylinder/Tanks

FOR YOUR SAFETY, you must provide the openings listed below for replacement air and ventilation of the grill enclosure (i.e. in case of possible gas leaks from connections or LP tanks/cylinders). Failure to do so may result in a fire or explosion causing property damage, bodily injury or death.

One side of the enclosure shall be kept completely open to the outside OR four (4) minimum ventilation openings MUST be provided:

- Each opening must have a minimum of 10 sq. in. of free area. The openings must be equally sized, providing a total of 40 sq. in.
- Two openings must be in the side walls of the enclosure, at the top and spaced a minimum of 90° from each other. The openings must begin 1" or less below the countertop edge and end no more than 5" below the countertop edge. See Figure 9.
- Two openings must be in the side walls of the enclosure, at the bottom (floor level) and spaced a minimum of 90° from each other. The openings must begin 1" above the floor level and end no more than 5" above floor level.
- **The openings must remain unobstructed:** The clearance between the openings and any items outside of the enclosure is a minimum of 6". The clearance between the openings and any items within the enclosure is a minimum of 2". This provides free flowing air inside and outside the enclosure to keep the island cool during operation of the grill. See Figure 9.

IMPORTANT:

Ventilation is required in the enclosure on opposite sides to create cross-ventilation. Liquid propane is heavier than natural gas and vents should be located near the bottom of the enclosure.

VENTILATION REQUIREMENTS

- Minimum 4 openings (2 per side wall spaced at 90°)
- Top openings: within 5" of countertop
- Bottom openings: within 5" of floor
- Each vent opening: Min. 10 sq. in. of free area (Total to = 40 sq. in.)

Vent openings must be kept clear and free at all times.

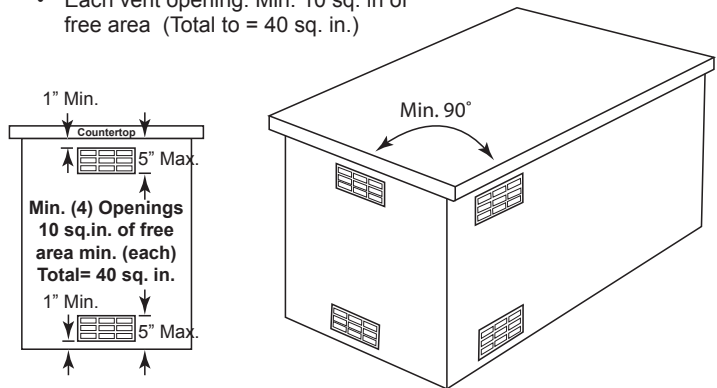

Figure 9

UNOBSTRUCTED VENT OPENINGS

- 6" Minimum clearance in front of all vent openings to any items outside the enclosure
- 2" Minimum clearance in front of all vent openings to any items inside the enclosure

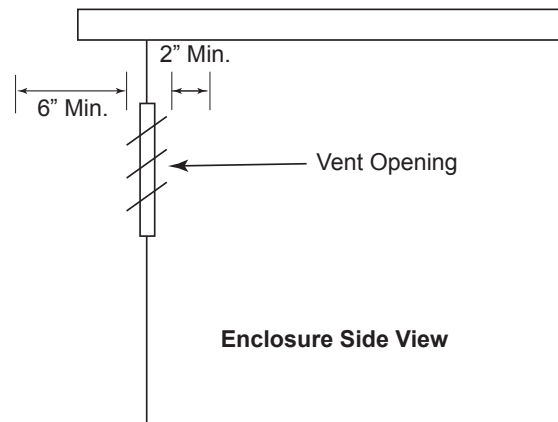

Figure 10

OPERATION & MAINTENANCE TIPS

READ INSTRUCTIONS BEFORE LIGHTING

SPARK IGNITION

CAUTION: Keep your face and body away from the grill top when lighting

Open the hood before lighting; do not attempt to ignite burners while hood is closed.

Make sure gas supply is turned ON.

Make sure burner control knobs are in the “OFF” position. DO NOT turn on more than one valve at a time for initial ignition.

1. Press in the control knob then slightly turn the knob counterclockwise while still pressing inward.
2. Hold in the above position for 5 seconds allowing the gas to reach the manifold.
3. Turn the knob counterclockwise past the ignition to the high setting to ignite. You will hear the one time clicking sound of the spark ignition.
4. If ignition does not occur in 5 seconds, turn the burner control OFF, wait 5 minutes, and repeat the lighting procedure.
5. After ignition, set the knob to the desired setting.

READ INSTRUCTIONS BEFORE LIGHTING

MANUAL (MATCH LIGHT) IGNITION

CAUTION: Keep your face and body away from the grill top when lighting

Open the hood before lighting; do not attempt to ignite burners while hood is closed.

Make sure gas supply is turned ON.

Make sure burner control knobs are in the “OFF” position. DO NOT turn on more than one valve at a time for initial ignition.

1. Place either a burning long-barrel butane lighter or a burning long-stem match near the manual flash tube to the right of the grill. For back burners, hold the flame against the surface of the back burner.
2. Hold the lighter or match flame at the top of the manual flash tube for five (5) seconds, or, next to the back burner. Then depress the appropriate control knob and while pressing turn it counterclockwise to the HI position. Remove the lighter or match when the burner lights and release the control knob.
3. If ignition does not occur in 5 seconds, turn the burner control OFF, wait 5 minutes, and repeat the lighting procedure.
4. After ignition, set the knob to the desired setting.

SHUT OFF INSTRUCTIONS

1. To shut OFF the grill, depress each valve control knob and while pressing turn clockwise to the “OFF” position.
2. Always close the valve from the gas supply after each use of the grill.

This appliance is designed as an “**ATTENDED APPLIANCE**”.
DO NOT leave this appliance burning when unattended.

OPERATION & MAINTENANCE TIPS

PRE-HEATING THE GRILL

Pre-heating your grill every time you use it is extremely important. Pre-heating allows the briquettes to properly heat up, providing more even and more consistent cooking results. Pre-heat your grill by igniting all main burners. Then close the hood and allow the grill to heat for 10 to 15 minutes, the hood thermometer should reach approximately 450°. Once you've reached your desired pre-heat temperature, turn OFF the burners that you won't be using to cook your food. Remember, surface temperature can be up to 200° higher.

SHUT OFF INSTRUCTIONS

1. To shut off the unit, depress each valve control knob and while pressing turn clockwise to the "OFF" position.
2. Always close the valve from the gas supply after each use of the unit.

NOTE:

When using a portable Propane tank: Propane tanks are equipped with a safety shutdown device that may cause low or no gas pressure/ flame at the burners if operating and lighting instructions are not followed exactly.

ADJUSTING YOUR BURNER TO A LOWER SETTING

- Make sure the grill is cool.
- Remove the racks so you can see the flames while adjusting the burners.
- Light the burner.
- Turn the burner to "LOW".
- Pull off the control knob.
- Use a flat head screw driver and adjust the "gold flathead screw" in the valve to the proper flame height.

MAINTENANCE TIPS

Stainless steels need to be cleaned for aesthetic considerations and to preserve corrosion resistance. Stainless steel is protected from corrosion by a thin layer of chromium oxide. Oxygen from the atmosphere combines with the chromium in the stainless steel to form this passive chromium oxide film that protects from further corrosion.

GRILL EXTERIOR

Routinely wipe down your grill exterior with warm water and finish by applying stainless steel polish.

Any contamination of the surface by dirt, or other material, hinders this passivation process and traps corrosive agents reducing corrosion protection. Thus, routine cleaning is necessary to preserve the appearance and integrity of the surface.

GRILL INTERIOR

- Burn off excess food debris and marinades for 15 minutes after cooking.
- Once the unit is cool, turn over the burner covers and burn the top side (the burner covers are reversible and are able to be mounted upside down for cleaning purposes).
- Use an approved stainless-steel oven cleaner to remove grease build up.
- Routinely have a professional barbecue cleaning company detail the barbecue for best results and longevity.

STAINLESS STEEL MAINTENANCE

After each use wipe down the exterior of the grill to remove grease and splatters. Use a commercially available stainless-steel cleaner to clean and polish the exterior surfaces. Doing these things on a regular basis minimizes the amount of effort required

When removing stubborn stains:

- Do not use metallic abrasives and always rub in the direction of the grain.
- Some household cleaning products are not suitable for stainless steel; be sure to read the label before using on the grill.
- Always use the mildest cleaning solution first, scrubbing in the direction of the grain.
- Specks of grease may gather in the grain of the stainless steel and bake on to the surface, giving the appearance of rust.
- To remove these baked-on foods use a fine to medium grit non-metallic abrasive pad (Scotch Brite is good) in conjunction with a stainless steel cleaner.
- Solutions used for cleaning concrete and masonry can be very corrosive and will 'attack' stainless steel
- Be sure your TrueFlame products are well protected before using these products.

OPERATION & MAINTENANCE TIPS

IMPORTANT NOTE: FOR LOCATIONS NEAR COASTAL AREAS AND POOLS:

#304 stainless steel materials used in the construction of your TrueFlame grill are highly rust resistant, however, chlorine in the air from swimming pools or the salt from sea air may cause surface rust to appear and even create some pitting if left on the product. Here are a few tips to avoid this if instructions are not followed exactly.

- Regularly wipe down the exterior surfaces with a damp cloth (micro fiber towels work well).
- Allow the surfaces to dry before installing the cover. Do not cover a damp grill
- In extreme environments apply a rust inhibitor which leaves a microscopic protective layer on the grill.
- For seasonal storage use the product referred to above, ensure the grill is dry, then cover and secure the cover to minimize the amount of damp air getting to the surfaces.

After your first use, certain areas of the grill may discolor from the intense heat given off by the burners; this is normal and cannot be cleaned off. For light and heavy food stains there are many different stainless; steel cleaners available.

OPTIONAL ACCESSORIES

Never operate grill unattended. **DO NOT OPERATE ROTISSERIE BURNER WITH WARMING RACK INSTALLED.**

ROTISSERIE INSTALLATION

1. Remove the warming rack, cooking grates, and burner covers if necessary.
2. Mount the rotisserie motor bracket on either side of the grill nearest the outlet.
3. Slide the rotisserie motor onto the rotisserie motor bracket.
4. Insert rotisserie spit (rotisserie rod) into motor.
5. Place 1st fork onto the rotisserie spit and secure tightly.
6. Position the meat onto the spit securing to the 1st fork.
7. Place 2nd fork onto the spit securing to the meat and tighten screw.
8. Insert collar onto spit.
9. Screw on handle nut and handle.
10. Add a drip pan beneath the meat to catch drippings and retain moisture in the meat.

HEAT-ZONE SEPARATOR INSTALLATION

To install the heat zone separators, please insert the heat zone separators between each burner.

OPTIONAL DROP-IN SEAR BURNER INSTALLATION

The preferred location to install a drop-in sear burner is on the far left of the grill. This will allow for a sear zone while maximizing the main burner grilling space.

To install a drop-in sear burner:

- Remove the grate and burner covers to access the main burner
- Remove the cotter pin securing the main burner (if necessary)
- Remove main burner
- Remove cross tube in between main burners allowing for drop-in sear burner to rest flat, if necessary
- Install sear burner with the center of the orifice positioned in the center of the burner and rest the back of sear burner flat on the rear of the grill. There is a locating pin in the rear of the sear burner that must be seated correctly.

LIGHTING DROP-IN SEAR BURNER

1. Open the hood before lighting; do not attempt to ignite burners while hood is closed.
2. Make sure gas supply is turned on.
3. Make sure burner control knobs are in the "OFF" position.
4. Press in the control knob then slightly turn the knob counterclockwise while still pressing in.
5. Hold in the above position for 5 seconds allowing the gas to reach the manifold..
6. Turn the knob counterclockwise past the ignition to the high setting to ignite. You will hear the one time clicking sound of the spark ignition.
7. After ignition, set the knob to the desired setting.
8. Using the main burner sear zone can cause extreme damage. 100% attention to this style of cooking is required.

GRILL ILLUSTRATIONS

TFE25

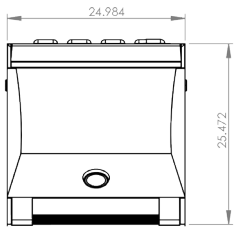

TOP VIEW

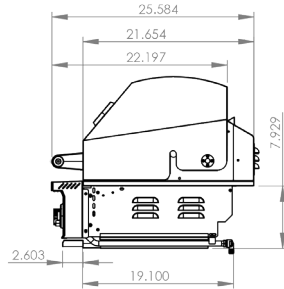

SIDE VIEW

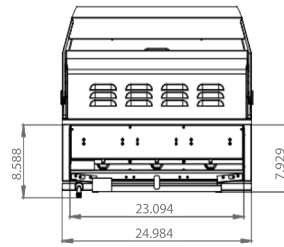

BACK VIEW

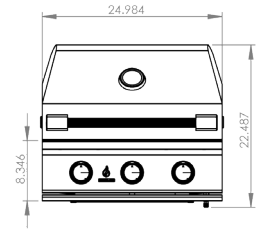

FRONT VIEW

TFE32

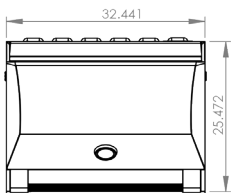

TOP VIEW

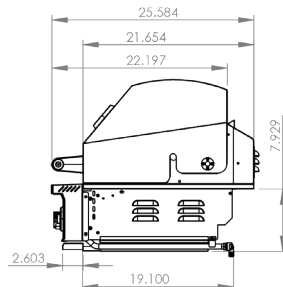

SIDE VIEW

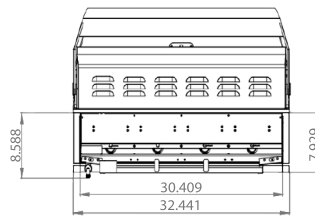

BACK VIEW

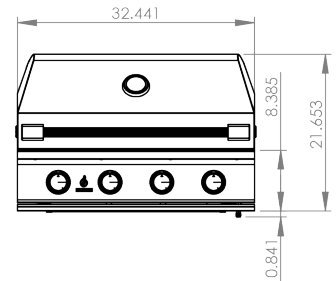

FRONT VIEW

ILLUSTRATED PARTS

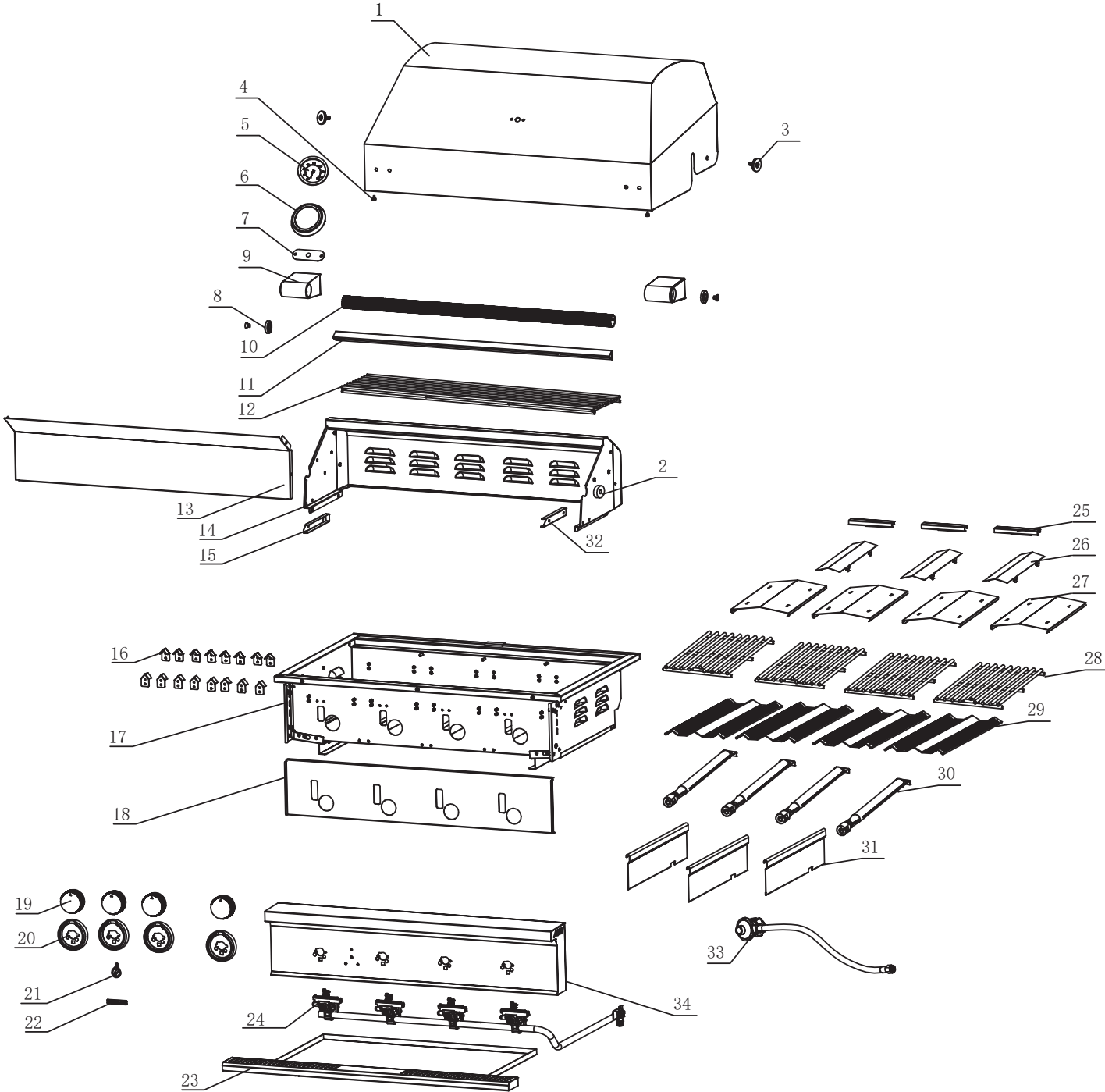

32" grill shown

PARTS LIST

ITEM	DESCRIPTION	TFE25 QTY.	TFE32 QTY.
1	11058 - TFE25 Hood	1	
	11059 - TFE32 Hood		1
2	11053 - TFE Hood Pivot Hardware	2	2
3	11273 - Shaft Sleeve	2	2
4	11120 - Rubber Bumper	2	2
5	11121 - Thermometer	1	1
6	11122 - Thermometer Bezel	1	1
7	11123 - Lining Cover Panel	1	1
8	11124 - Handle Cover	2	2
9	11125 - Handle Seat	2	2
10	11126 - 25" Grill Handle	1	
	11127 - 32" Grill Handle		1
11	Rear Baffle Assembly	1	1
12	11056 - TFE25 Warming Rack	1	
	11057 - TFE32 Warming Rack		1
13	Firebox Back Wall Lining	1	1
14	Firebox Back Wall Assembly	1	1
15	11141 - Warming Rack Left Support	1	1
16	11145 - Flame Tamer Support	12	16
17	11146 - 25" Firebox Assembly	1	
	11147 - 32" Firebox Assembly		1
18	11274 - TFE25 Heat Shield	1	
	11275 - TFE32 Heat Shield		1
19	11049 - Knob	3	4
20	11050 - Knob Bezel	3	4

ITEM	DESCRIPTION	TFE25 QTY.	TFE32 QTY.
21	11154 - Logo-1	1	1
22	11155 - Logo-2	1	1
23	11156 - 25" Grill Drip Tray	1	
	11157 - 32" Grill Drip Tray		1
24	11288 - TFE25 Manifold	1	
	11298 - TFE32 Manifold		1
	11290 - TFE NG Main Valve	3	4
	11291 - TFE LP Main Valve	3	4
	11292 - TFE NG Main Valve Orifice	3	4
	11293 - TFE LP Main Valve Orifice	3	4
25	11166 - Crossfire	2	3
26	11167 - Upper Oil Leakage Plate	2	3
27	11168 - Oil Leakage Plate	3	4
28	11055 - Cooking Grate	3	4
29	11170 - Flame Tamer	3	4
30	11054 - TFE Burner	3	4
31	11172 - Heat Zone Separator	2	3
32	11174 - Warming Rack Support-R	1	1
33	TF-REG HOSE LP - LP Regulator & Hose Assmebly (LP Model)	1	1
33	10919 - NG Regluator (NG Model)	1	1
34	11051 - Control Panel	1	
	11052 - Control Panel		1



GOLD STANDARD WARRANTY

Your investment in TrueFlame products is backed by the strongest warranty in the industry. In addition to precision engineering and outstanding performance, TrueFlame products include our GOLD STANDARD LIFETIME WARRANTY with all replacement parts 100% non-prorated. Effective with purchases as of 3/1/23.

TrueFlame Warranty is valid for original purchaser at original site of delivery with proof of purchase and photo documentation only. Registration form must be submitted online within 30 days of the purchase date to validate the warranty. Warranty is void upon transfer of ownership. Warranty does not apply to products installed in any commercial, rental, or nonresidential application that have not maintained proper upkeep. Warranty covers replacement parts only. Manufacturer is not responsible for labor or labor-related costs. Warranty does not cover discoloration, surface rust, corrosion, or oxidation, which may occur due to harsh environments, chemicals, or overheating. Warranty will not apply for damage resulting from improper installations, abuse, extreme environments, grease fires, or misuse. Proof of regular and proper maintenance is required. Coastal, humid, and/or salt environments are subject to manufacturer review. All out-of-box claims must be made within 30 days of purchase and must be made prior to installation. Any product installed damaged will be considered damaged during installation and not covered under warranty. Warranty and registration forms are available at www.amddirect.com/register. Please be advised - all display models are sold "as is" and the warranty covers the following items only: main burners (Gold Standard Lifetime Warranty), grates (Gold Standard Lifetime Warranty), burner covers (Gold Standard Lifetime Warranty). All warranties are subject to the review and approval of the manufacturer.

14520 DELTA LANE SUITE 105,
HUNTINGTON BEACH, CA 92647

800.966.8126

AMDDIRECT.COM

Scan this QR code
to view warranty details:





Scan this QR code to view cutout details:



For more information call
Customer Care at 800-966-8126
Hours: 7am - 5pm PST

14520 DELTA LANE SUITE 105
HUNTINGTON BEACH, CA 92647
800.966.8126